

RIELLO 40 F SERIES

The Riello 40 F series of one stage light oil burners, is a complete range of products developed to respond to any request for light industrial applications. The Riello 40 F series is available in three different models, with an output ranging from 30 to 202 kW, divided in three different structures.

All the models use the same components designed by Riello for the Riello 40 F series. The high quality level guarantees safe working.

In developing these burners, special attention was paid to reducing noise, to the ease of installation and adjustment, to obtaining the smallest size possible to fit into any sort of boiler available on the market.

All the models are approved by the EN 267 European Standard and conform to European Directives for EMC, Low Voltage, Machinery and Boiler Efficiency.

All the Riello 40 F burners are fired before leaving the factory.



F5	30 ÷ 60 kW
F10	54 ÷ 107 kW
F20	95 ÷ 202 kW

FIRING RATES

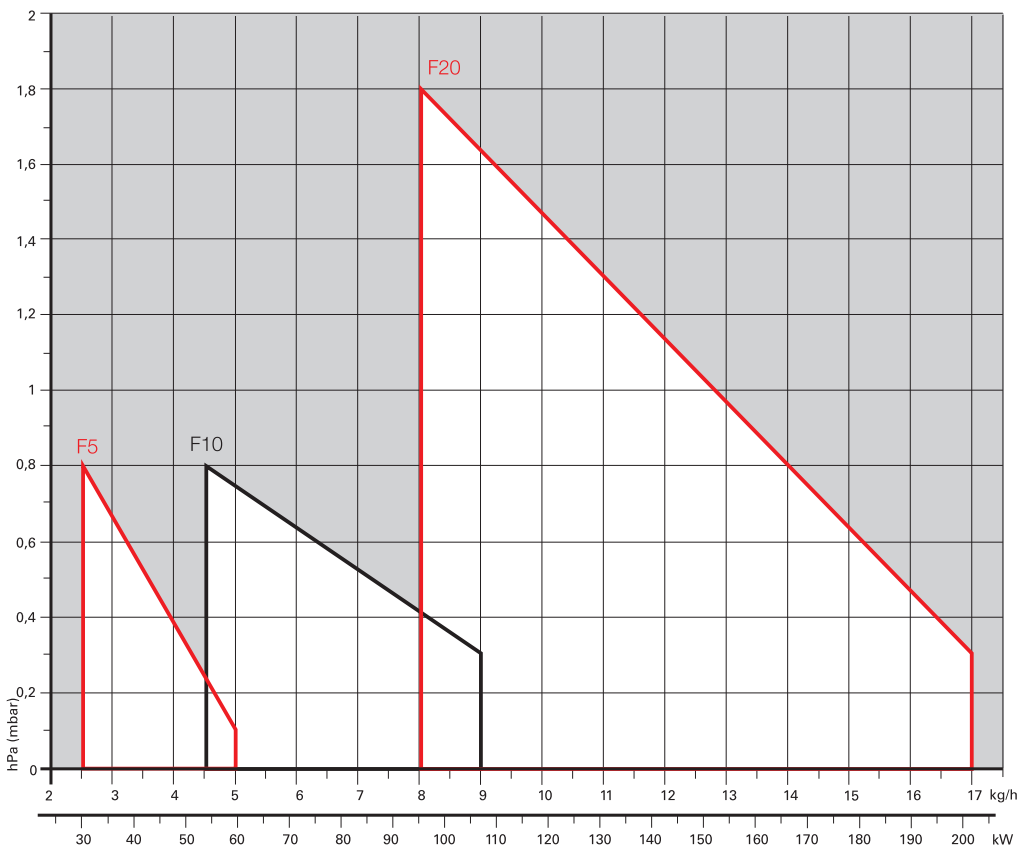

Useful working field for choosing the burner

Test conditions conforming to EN267
 Temperature: 20°C
 Pressure: 1013,5 mbar
 Altitude: 0 m a.s.l.

One Stage Light Oil Burners

RIELLO 40 F SERIES

Overall dimensions (mm)

BURNER

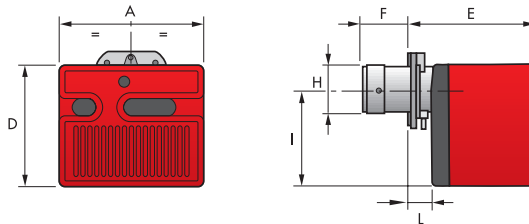

MODEL	A	D	E	F	H	I	L
► F5	272	233	240	72	89	180	41
► F10	305	262	265	104	105	204	44
► F20	350	298	299	118	125	230	45

BURNER - BOILER MOUNTING FLANGE

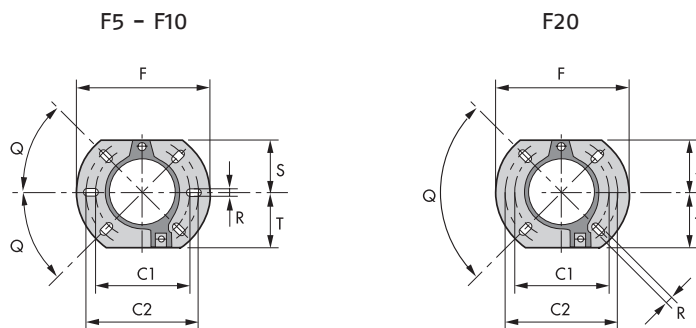

MODEL	C1	C2	F	Q	R	S	T
► F5	130	150	180	45°	11	72	75
► F10	140	170	189	45°	11	83	83
► F20	160	190	213	90°	11	99	99

PACKAGING

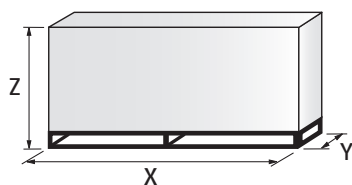

MODEL	X	Y	Z	kg
► F5	383	315	325	12
► F10	423	348	340	13
► F20	483	393	377	16

RIELLO 40 F SERIES

Specification

DESIGNATION OF SERIES

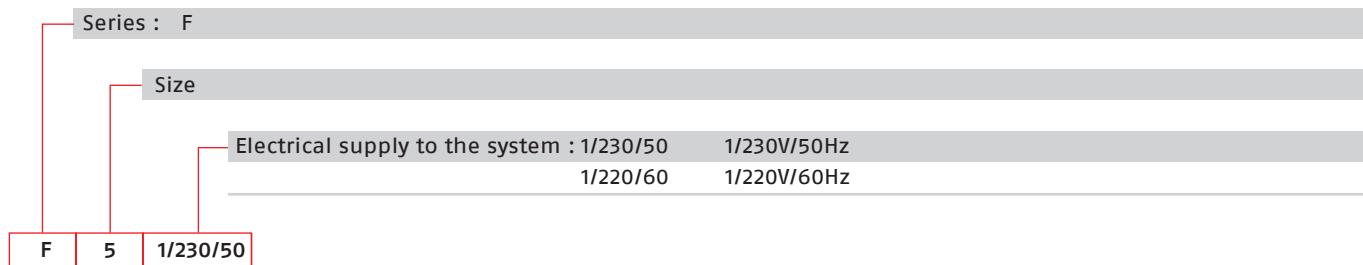

STATE OF SUPPLY

Completely automatic monobloc light oil burners, one stage operation, made up of:

- Fan with forward curve blades
- Metallic cover
- Fixed air damper with adjustment
- Single phase electric motor 230 V, 50 Hz
- Combustion head fitted with:
 - stainless steel head cone, resistant to high temperatures
 - ignition electrodes
 - flame stability disk
- Geared pump for fuel supply, fitted with:
 - filter
 - pressure regulator
 - attachments for fitting a pressure gauge and vacuum meter
 - internal by-pass for preparing for single-pipe installations
- Fuel feed solenoid valve incorporated in the pump
- Photocell for flame detection
- Electronic flame control equipment
- Light oil nozzle
- IP X0D (IP 40) protection level.

Standard equipment:

- Two flexible pipes for connection to the light oil supply line
- Two nipples for connection to the pump
- Flange, screws and nuts for fixing
- Thermal screen
- Instruction handbook for installation, use and maintenance
- Spare parts catalogue.

One Stage Light Oil Burners

RIELLO 40 F SERIES

Available models

CODE	MODEL		HEAT OUTPUT		TOTAL ELECTRICAL POWER (kW)	CERTIFICATION	NOTE
			(kW)	(kg/h)			
3451083	F5	1/230/50	30 - 60	2,5 - 5	0,130	-	
3746159	F5	1/220/60	30 - 60	2,5 - 5	0,180	-	
3452083	F10	1/230/50	54 - 107	4,5 - 9	0,170	-	
3746260	F10	1/220/60	54 - 107	4,5 - 9	0,200	-	
3452783	F20	1/230/50	95 - 202	8 - 17	0,320	-	
3747260	F20	1/220/60	95 - 213	8 - 18	0,400	-	

Net calorific value: 11,8 kWh/kg - 10200 kcal/kg - Viscosity at 20°C: 4±6 mm²/s (cSt)
The burners of F series are in according to EN 267.

Bio fuels

Riello Burners is able to offer technical variants which allow burners to be used within environmental heating, process or special applications. These applications now include solutions for liquid Bio fuels (i.e. biodiesel and vegetable oil). Our experience in research and development and field applications with organic origin Bio fuels has resulted in Riello being able to offer a wide range of solutions for the combustion of Bio fuels.

Kerosene and ULSD

Riello 40 F series burners can be supplied, on demand, suitable for applications where combustion of Kerosene, Low Sulphur Kerosene and Ultra Low Sulphur Diesel Oil (ULSD) is the chosen fuel.

These burner variants can be provided upon request and after a technical-commercial evaluation; for more information please contact Riello Burners Commercial and Technical Department, our Application Engineers will be pleased to help you.

Burner accessories

Remote control release kit for 530 SE control box

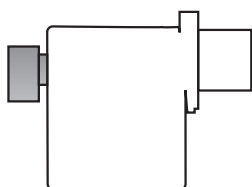

The 530 SE control box can be remotely released using an electric command kit. This kit must be installed in conformity with current regulations in force.

BURNER	KIT CODE
▶ F5 - F10 - F20	3001030

Extended head kit

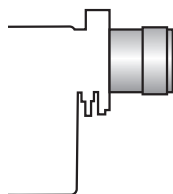

Kits of extended heads are available.

BURNER	STANDARD HEAD LENGTH (mm)	EXTENDED HEAD LENGTH (mm)	KIT CODE
▶ F5	72	90	3006001
▶ F5	72	90 inox	300688
▶ F5	72	107	300638
▶ F5	72	121	300686
▶ F5	72	121 inox	300687
▶ F10	104	168	300643
▶ F10	104	250	300770
▶ F20	118	178	300644
▶ F20	118	260	300771

Burner accessories

Spacer kit

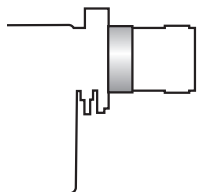

Using the special accessories, the burner can be pulled back to reduce head penetration into the combustion chamber.

BURNER	SPACER THICKNESS S (mm)	KIT CODE
► F5	25	3000642
► F10	25	3000672
► F20	25	3000673

Inlet air aspiration kit

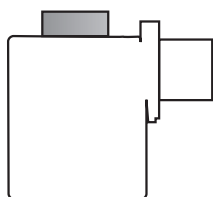

This kit allows to channel the external air directly into the burner and is available as accessory for models:

BURNER	KIT CODE
► F5	20027574
► F10	20027577
► F20	20027580

Light oil filter



For cleaning light oil from dirty particles and impurities filters with the following features are available:

BURNER	FILTERING DEGREE (µm)	KIT CODE
► All models	60	3006561

Filter made up of aluminium body and stainless steel filtering cartridge; available singularly.

BURNER	FILTERING DEGREE (µm)	KIT CODE
► All models	60	3075011

Filter made up of aluminium cover, plastic tank and nylon filtering cartridge; available in packaging of 50 pieces.

Light oil filter/degassing unit



To solve problems of air or water in the oil circuit a special filter/degassing unit is available, made up of aluminium cover, plastic tank, stainless steel filtering cartridge, air release cap and water purge valve. It is available singularly.

BURNER	FILTERING DEGREE (µm)	KIT CODE
► All models	100	3000926

7-pin plug kit

If necessary a 7-pin plug kit is available (in packaging of n. 5 pieces).

BURNER	KIT CODE
► All models	3000945

One Stage Light Oil Burners

RIELLO 40 F SERIES

Burner accessories

Hour counter kit for 530 SE and 531 SE control boxes



To measure the burner working time a hour counter kit is available.

BURNER	KIT CODE
► All models	3000904

7-pole socket kit for 530 SE and 531 SE control boxes

For burner without pre installed socket a 7-pole socket kit with cable is available.

BURNER	KIT CODE
► All models	3001065